

G19S







VEHICLE GPS TRACKER



GPS tracker G19S is a smart GPS tracking device which integrated GSM technology, GPS technology, built-in antenna and sensors. It has functions like ACC detection, vibration alarm, SOS emergency call, remotely cut-off petrol/electricity. If connected with microphone, the user can hear what is happening around vehicle.

G19S is designed to allow vehicle owners to track the location of their properties over smart phones and provide real-time car tracking for individual vehicles or entire fleets.

FUNCTION

-  Real-time Tracking
-  Remotely Cut-off Petrol/Electricity
-  SOS Emergency Call
-  Remotely Voice Monitoring
-  Built-in Battery
-  Multiple Alert Protections

PARAMETER

Size	83mm(L)*40mm(W)*14mm(H)	Weight	52g
Working Temperature	-25°C to 75°C	Built-in Battery	250mAh
Working Voltage	9-90V		

HARDWARE SPECIFICATION

Location Accuracy	<=10m	Channel	20 Class
GPS Chip	MT2503D	GPS Sensitivity	-144dBm
GSM Frequency	850/900/1800/1900MHZ	Tracking Sensitivity	-160dBm
Positioning Time	Hot Start<2SEC(Open Sky)	Power LED Indicator	Red
	Warm Start<15SEC	GPS LED Indicator	Blue
	Cold Start<38SEC(Open Sky)	GSM LED Indicator	Green
GSM Antenna	Spring Antenna		
GPS Antenna	Built-in 25mm*25mm*4mm Ceramic Antenna		
GPRS	Class12. TCP/IP Built-in GSM Module		

SOFTWARE SPECIFICATION

Data Upgrade Port	Not Support	ACC Detection	Support
Function Port Definition	Not Support	Geo-fence	Support
Parameter Setting	SMS Command, Platform	Cut-wire Alarm	Support
GPRS Upload	Upload Interval Every 10 Seconds	Vibration Alarm	Support
Third-party Checking	WEB/APP	Movement Alarm	Support

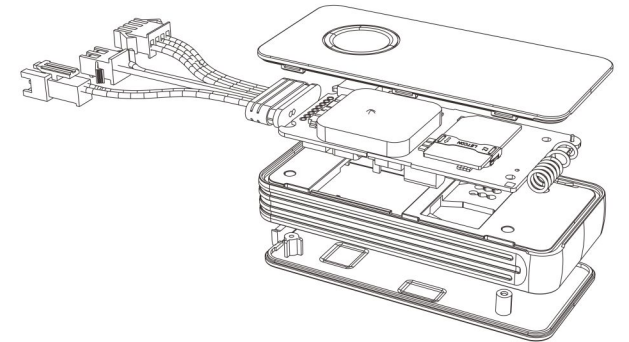

APPLICATION



Car Tracking



Fleet Management



Truck Tracking